

Strait Shores Wind Project

Landowner Information Meeting

June 19, 2024



Land Acknowledgement

We acknowledge that our company operates on the traditional territories of Indigenous peoples across Canada, Australia, and the United States. We recognize the rich and diverse histories, cultures, and contributions of the First Nations, Inuit, Métis, Aboriginal, and Native American communities. It is with gratitude and respect that we thank the Peoples who have lived on these lands for generations for reminding us of the ongoing histories that precede us.



Welcome to TransAlta's Strait Shores Wind Landowner Meeting

Thank you for joining us. We invite you to view the display boards and speak with the Project Team Members to share your thoughts and have your questions answered.

Our experienced wind development team are available to answer any of your questions or discuss any of your interests.





TransAlta at a Glance

TransAlta is Canada's largest wind power generator

- TransAlta has over 113 years of generation experience
- Owner of Canada's first commercial wind farm located in Pincher Creek, Alberta
- The first company in Canada to responsibly decommission a wind site at end of life
- TransAlta owns and operates a diverse generation fleet comprising of natural gas, wind, hydro, solar, battery and coal* facilities for a total net capacity of over 8,700 MW across North America and Western Australia
- Owns and operates 23 wind facilities generating 1,895 MW of clean renewable power across Canada and the US

*Note: TransAlta is currently transitioning out of coal with the only remaining facility, Centralia in the USA, expected to be retired at the end of 2025.



Strait Shores Wind Project

TransAlta is planning the Strait Shores Wind Project within the blue outlined area (pictured right).

The project is not planned to cover the entire area and will be reduced when an initial project layout has been designed.



What does the Project Involve

- **Approximately 32 turbines** – Each with a generating power of 6.2 MW and with a tip height of approximately 200 meters
- **One 60m meteorological tower** used to gather information on the weather to understand how the turbines are performing
- An **underground collector system** to bring the power generated by the turbines to a **central substation**
- A **transmission line** between 750m and 1km long to connect the project to the existing electrical grid

TransAlta plans to use existing roads and access points as much as possible. Where necessary, we will seek approval to upgrade and use municipal roads. Any new roads required will be designed to minimize environmental impacts and support existing land uses.

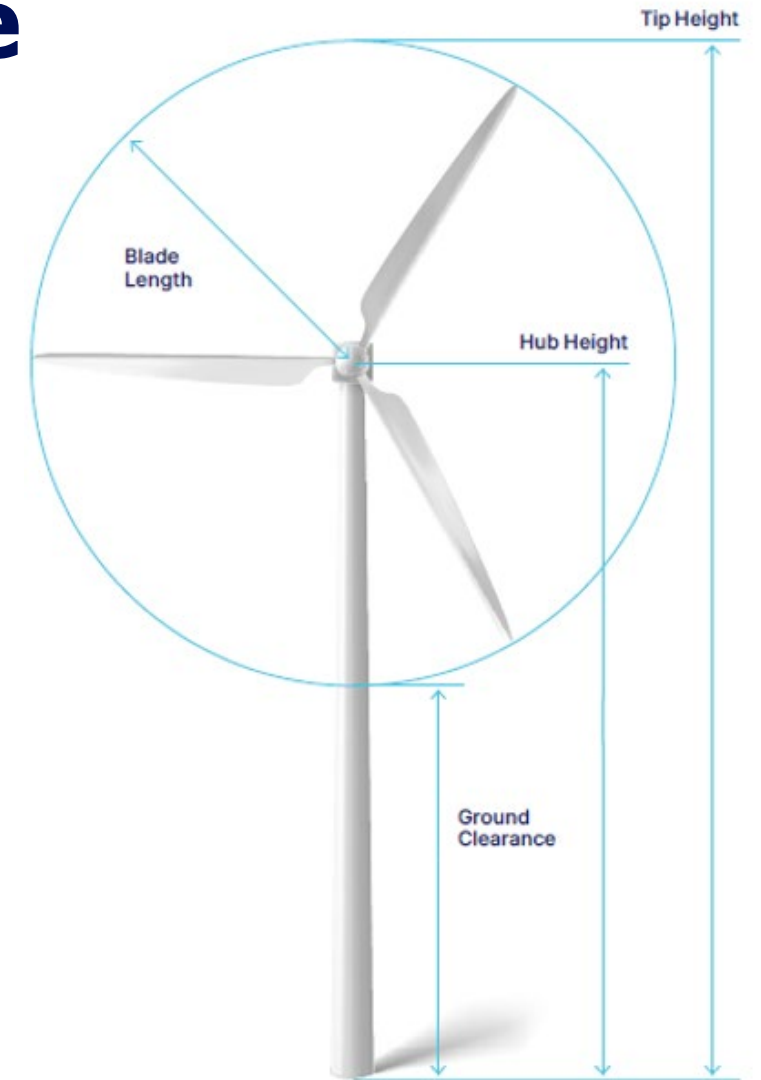

**Information subject to change as development work advances*



Proposed Project Development Timeline

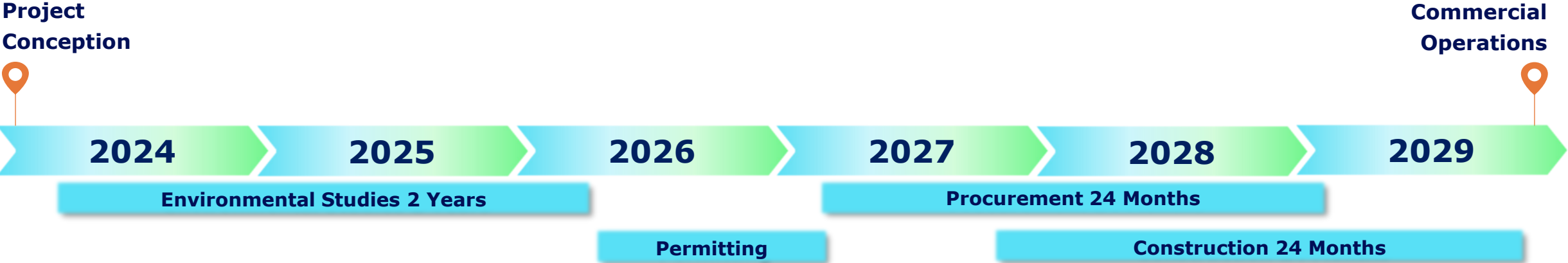

Project Development

- Interconnection feasibility studies
- Preliminary Engineering
- Geotechnical Works
- Land Acquisition
- Stakeholder consultation
- Met Tower Installation
- Engineering FEED
- Procurement activities
- Regulatory Applications

Execution

- Procurement
- Construction
- Commissioning
- Ongoing Stakeholder Engagement



Land Leases

TransAlta is interested in discussing land leases with landowners in the area. Benefits of signing up include:

- TransAlta is an established, proven developer of wind projects on private land
- Being a part of the journey to decarbonization
- Compensation for use of your land

Speak with one of our agents to understand the leasing process and next steps



Project Benefits



Employment Opportunities

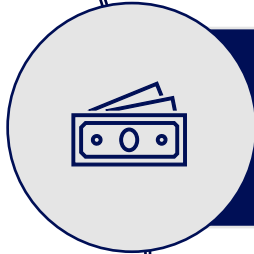

Tax Revenue for municipal, provincial and federal governments

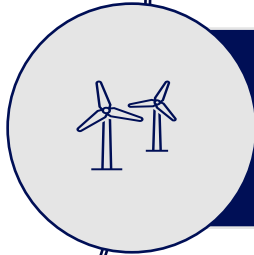

Sustainable fuel and stable prices

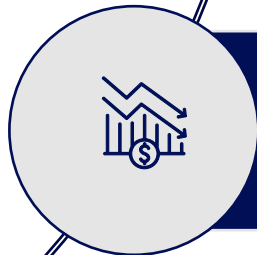

More cost-competitive than any other new source of energy





All surveys will be completed in consultation with the New Brunswick Department of Environment and Local Government (NBDELG).

Environmental Studies

Baseline avian and bat surveys

Spring and fall acoustic bat monitoring

Fish and Fish Habitat (if applicable)

Habitat mapping and rare plants

Wetlands and watercourses

Species at Risk (SAR) and Species of Concern (SOC)*

Archaeological field studies

The Wind Turbines and Birds: a Guidance Document for Environmental Assessment (CWS, 2006), the New Brunswick Wetland Guidelines (DELG, 2021), and the Guidelines to Avoid Harm to Migratory Birds (Government of Canada, 2023) will be followed.





Photo: TransAlta McBride Lake Wind Project

Other Studies



Shadow Flicker



Noise Impact Assessment



Visual Impact Assessment

Additional studies will be completed per the Wind Turbine sector-specific Guidelines (NBDELG, 2019) and TransAlta's experience developing wind projects.



Wind Project Development/Construction

- **Prospecting:** Identify potential locations for a wind farm
- **Resource Analysis:** Potential wind farm layout optimization and production analysis
- **Engineering:** Design foundations, a substation, a collector system and access roads
- **Wind Turbine supply:** Wind turbine components are shipped to the wind farm site where final assembly takes place
- **Site Preparation and Construction:** Construct access roads, build turbine foundations, assemble turbine components and turbine erection
- **Commissioning:** Substation energization and grid connection
- **Operation and Maintenance:** Monitor and analyze performance, perform preventive and corrective maintenance





Community Engagement Stages

- Today's session is TransAlta's first event in the Strait Shores area.
 - We will continue to engage with local stakeholders and community members as the Strait Shores Wind Project is planned.
- After a preliminary layout has been designed, TransAlta will conduct an open house.
 - Local stakeholders and other interested parties will be invited to comment on the Project.
- TransAlta will use the feedback collected at the open house and during our other engagement activities to refine the proposed design of the Strait Shores Wind Project.



Questions?

Please use feedback forms to provide feedback, ask questions, or request follow-up information.

Email: canadian_projects@transalta.com

Phone Number: 1-877-547-3365 X 1

Website: <https://transalta.com/about-us/our-operations/projects-in-development/strait-shores/>



Third-Party Consultants



Hatch Ltd. is an employee-owned company which was founded in 1955 in Toronto; today it has over 9,000 employees working in 78 offices around the world. Hatch provides process and business consulting, technology and engineering, project and construction management (EPCM) services to clients in the energy, mining & metals and infrastructure sectors. Hatch is supporting TransAlta's Geotechnical Program and Meteorological Tower Installation.



WSP. WSP is a global professional services firm that offers a wide range of engineering and environmental consulting services. WSP provides expertise in various engineering disciplines, including transportation, infrastructure, buildings, and energy. With a team of over 7,500 environmental experts, WSP is passionate about studying, protecting, enhancing, and restoring the natural environment. WSP provides process and business consulting, technology and engineering, and project and construction management (EPCM) services to clients in the energy and infrastructure sectors. WSP is supporting TransAlta with Engineering, Environmental Services and Stakeholder Engagement.





Photo: TransAlta Big Level Wind Project

Environmental Assessments: Siting

- To understand existing site conditions, a desktop assessment of publicly available environmental data (GeoNB) was completed for the area of interest.
- The Land is mostly forested, with interspersed wetlands, watercourses and agricultural land.
- Setbacks to environmental features will be applied as required by the New Brunswick Department of Natural Resources (NBDNR).
- Sensitive environmental features (e.g., wetlands, watercourses, bird nests, etc.) will be avoided during the project siting and designing process.

Siting Considerations





TransAlta's Kent Hills Wind Project

- In partnership with local development partner Natural Forces Technologies Inc.
- The first wind facility in New Brunswick
- The project is located on Crown Land in the Kent Hills area and was completed in three phases

Facts & Figures	
Location:	Kent Hills, NB
Fuel:	Wind
Capacity (MW):	167
Ownership:	83%
Operator:	Yes
First on-stream:	2008
Revenue Source:	LTC
Builder:	Yes
Contract Expiry:	2035



In an average wind year, Strait Shores would be able to produce enough energy to:



Power 92,000 households

*at 600kWh/household/month, 0.101kWh/L,
0.22kWh/km, 0.0503t/GJ NG @7.0 MHR*

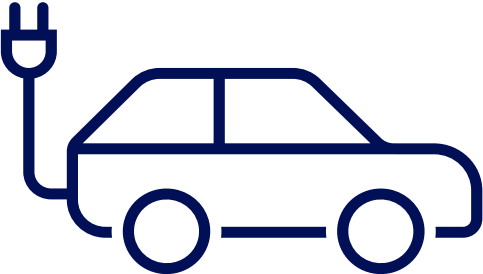

Charge and drive an EV for 3 billion kilometers

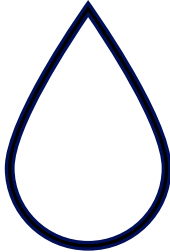

Boil 6.6 billion liters or 2,640 Olympic swimming pools of water

Strait Shores would offset 235,000 metric tons of carbon dioxide (CO₂)



Wind Turbine Foundations

- Planned "Gravity" foundations, which are a spread-type foundation
- Utilizes a large, shallow base that is covered in soil, to distribute the turbine forces over a large area
- The depth of the base is slightly deeper than a typical home basement

The diagram below shows a typical foundation size compared to a typical home foundation.

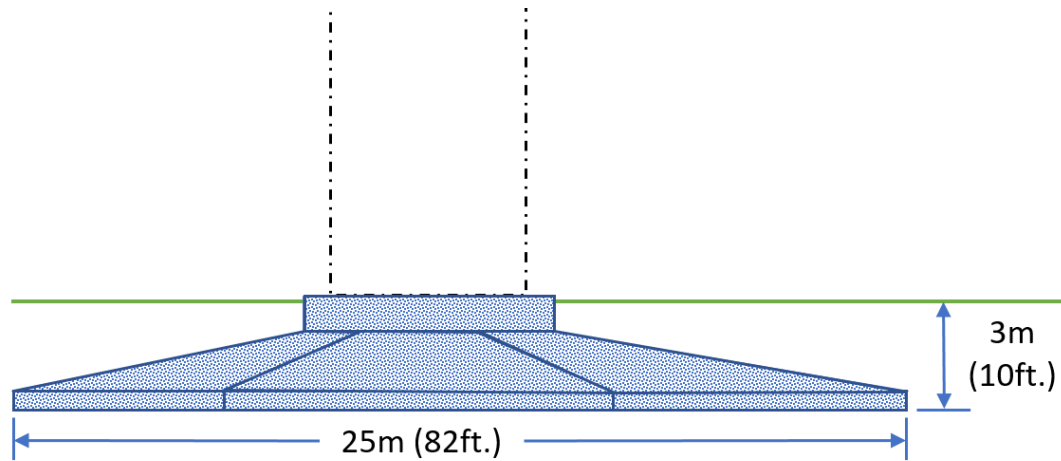

Wind Turbine Foundation (Typical)



Different onshore wind turbine foundation types

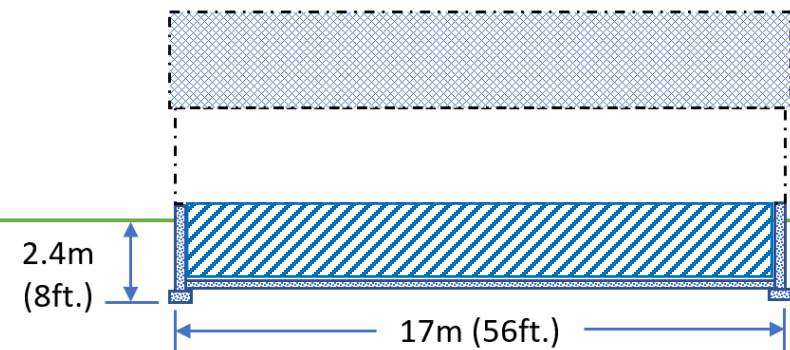

Home Foundation



What is a BESS? (Battery Energy Storage System)

1

Battery

2

Inverters

3

MV Transformers

4

HV Transformer

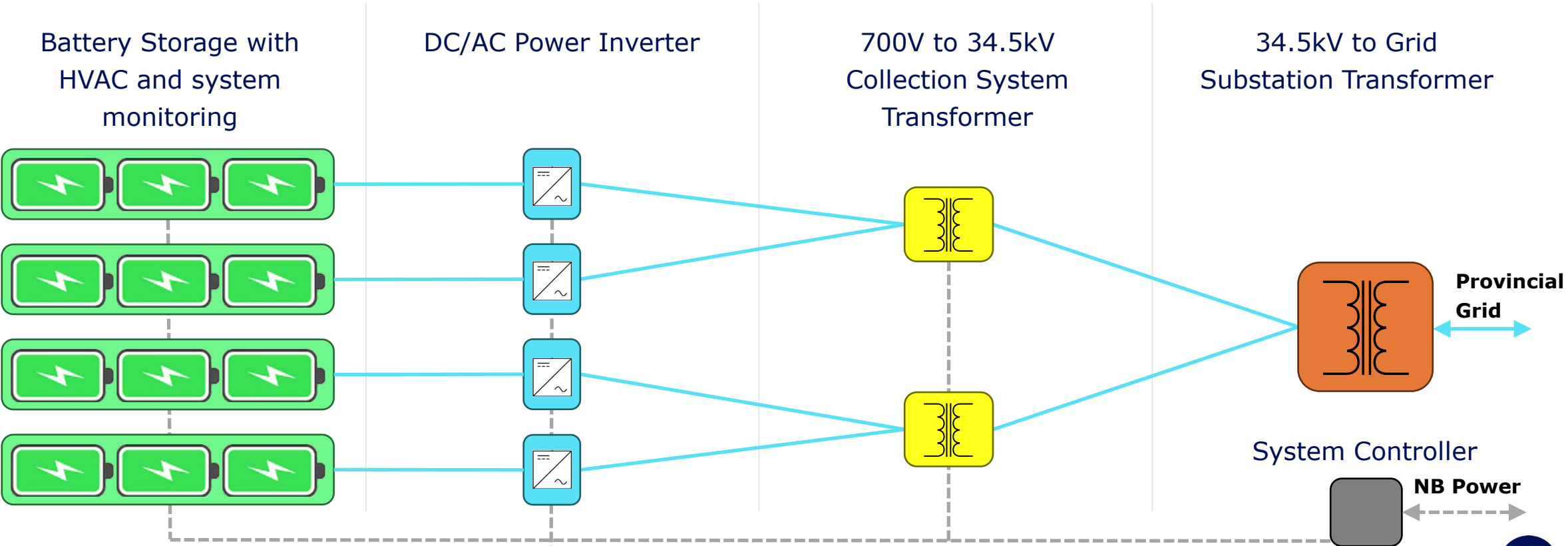

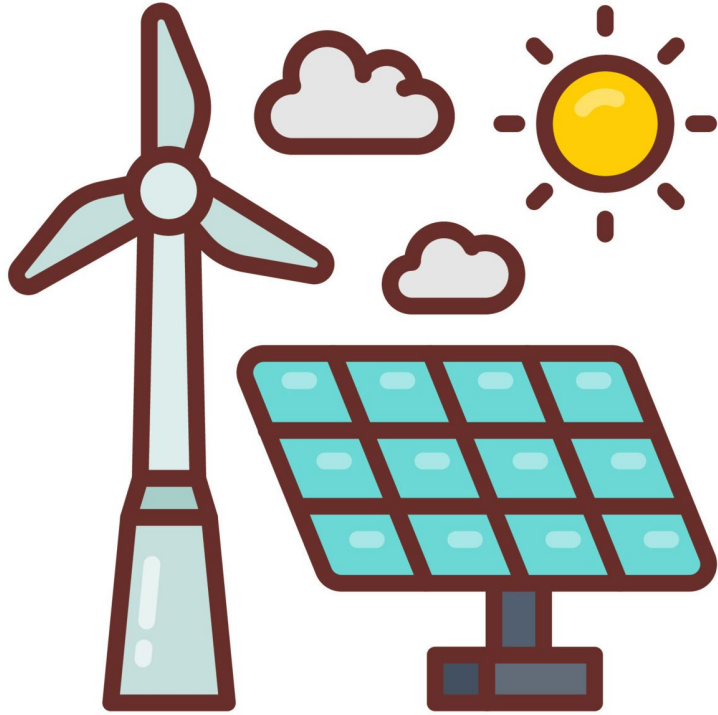

What value does a BESS add to the power grid?

Energy Storage enables greater renewable additions to the grid, but **HOW?**

- Energy Shifting
 - Shift and smooth renewable energy production to match generation and load
- Energy Capacity
 - Provides energy while slower ramping, dispatchable resources are starting
- Voltage support/stabilization
- Frequency regulation
- Operate as a Virtual Machine to provide system inertia
- Respond to grid needs within fractions of a second for fast frequency response





WindCharger (COD: 2020)

- TransAlta owns and operates Alberta's first utility-scale battery storage facility, 10 MW / 20 MWh
- Collocated with our Summerview Wind Farm
- The Project uses TESLA's MegaPack battery technology, the second ever commercial deployment of this utility scale pre-engineered storage solution

Northern Goldfields (COD: 2023)

- The Northern Goldfields Solar and Battery Storage Facility consists of the:
 - 27.4 MW Mt Keith Solar Farm
 - 10.7 MW Leinster Solar Farm
 - 10.1 MW Leinster battery energy storage system
- These assets integrate into TransAlta's existing 169 MW **Off-Grid** remote network in Western Australia

WaterCharger (In progress)

- 180 MW BESS collocated with our Ghost Lake hydro facility
- Developed and permitted

TransAlta's Recent BESS Projects





All studies will be completed following NBDLG (NBDLG 2019) Guidance

Shadow Flicker

- The effect of the sun shining through the blades of a wind turbine as they rotate, casting a moving shadow on the landscape.
- Sensitive shadow flicker receptors consist of occupied lands and public roadways.
- A shadow flicker model will be developed identifying potentially sensitive receptors within 2 km of the project.

Visual

- Visual simulations of the proposed project are created using specialized software.
- These simulations provide a representative depiction of the wind turbines on the landscape for areas of interest and significance for the surrounding communities.



Sound Levels

The sound from wind projects must follow the New Brunswick Department of Environment and Local Government (NBDELG), Environmental Impact Assessment Branch- *Additional Information Requirements for Wind Turbines* (NBELG, 2019)

Sound levels at sensitive receptors (within 1 km of the Project) will not exceed the outdoor noise thresholds recommended by the Canadian Wind Energy Association (HGC 2007).

Predicted noise levels are crucial for siting wind turbines. Our wind farm will not exceed 40 dBA at low wind speeds and 50 dBA at high speeds.

When siting turbines, TransAlta maintains a minimum of 800 m from houses regardless of the expected noise output

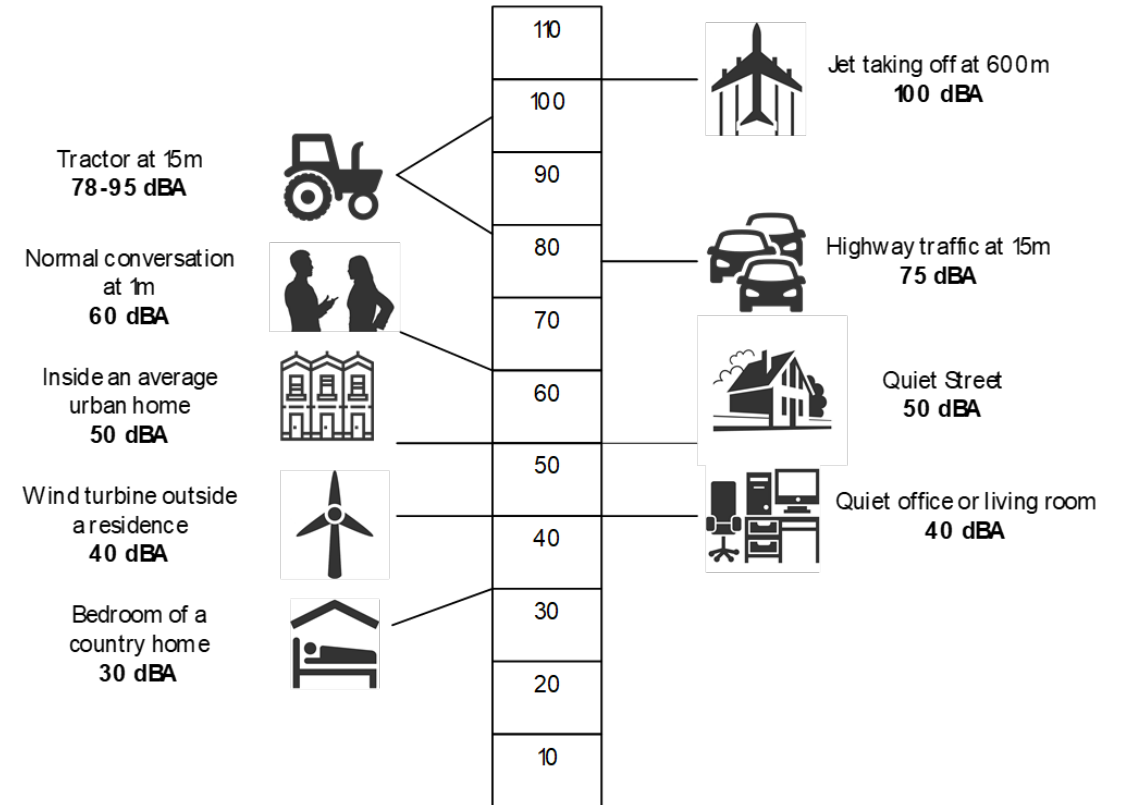

Indigenous Consultation and Engagement

Our Indigenous Relations Policy focuses on five key areas

- Community engagement and consultation
- Business development
- Community investment
- Employment
- Training and awareness

The policy includes our acknowledgement and understanding of the intent of the recommendations of the United Nations Declaration on the Rights of Indigenous Peoples.

We strive to maintain relationships through the life cycle of our operations, from project development and construction, through operation, until decommissioning phases are complete. We work with communities to build relationships based on a foundation of ongoing communication and mutual respect.



**Indigenous Relations
at TransAlta**



Decommissioning and Reclamation



TransAlta is the first company in Canada to fully decommission a wind farm

- A wind farm usually lasts between 30 and 35 years.
- Cowley Ridge was the first wind farm developed in Canada and was safely decommissioned by TransAlta in 2022.
- TransAlta is committed to reclamation and will develop a site-specific reclamation plan for the Strait Shores Wind Project. Our plan will include reclamation monitoring to ensure lands achieve their equivalent land use before the development of wind farm.

Wind turbines are 85-95% recyclable

Wind turbine towers are made of steel. The turbine blades are made of fiberglass and can be recycled by cutting them up into small pieces and then shredding them.

The shredded material can then be used in making cement or even thick plastics. Fibreglass can also be recovered and repurposed. Most of what remains (steel, iron, aluminum, copper, and electronic components) is also completely recyclable through existing programs.

